

BENEFITS:

- Ready to use once charged
- Stay charged longer when not in use
- Compatible with high to low drain devices
- Can be charged in most rechargeable chargers
- Cost saving & environmentally friendly

APPLICATIONS BEST FOR:

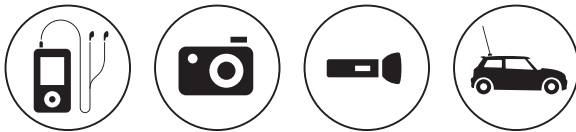

OTHER DETAILS:

- Nickel Metal Hydride chemistry
- Nominal voltage 1.2V
- Gross weight ~31g

BATTERY HANDLING

- Batteries should be charged prior to use.
- Remove batteries from the electrical device if the device is not going to be used for a long period of time.
- Do not mix new batteries in use with semi-used batteries.
- In order to maintain satisfactory cell / battery performance when being stored under extending period of time, fully charge the cell / battery within 12 months period is highly recommended.



- **GP 2600 series**
Rechargeable battery
- **AA size**
- **Minimum capacity 2600mAh**

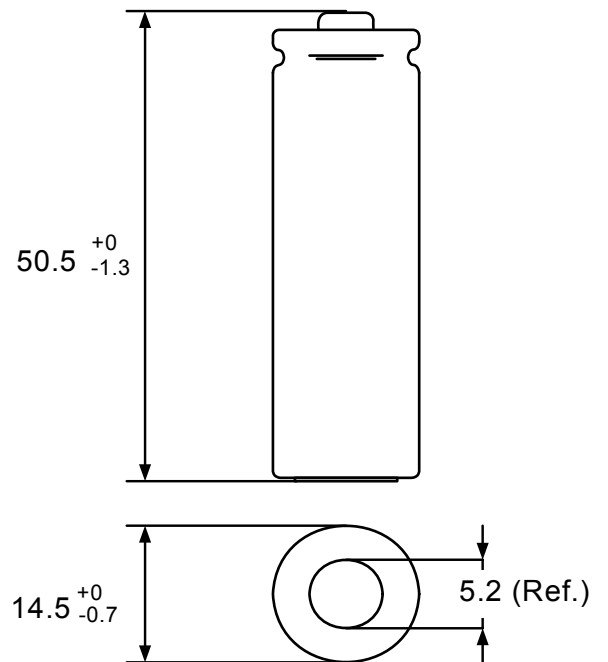

Unit : mm